

# Data Sheet



Article number: 03512200

Description: Fluro Rod end GE 200AW

## Measures

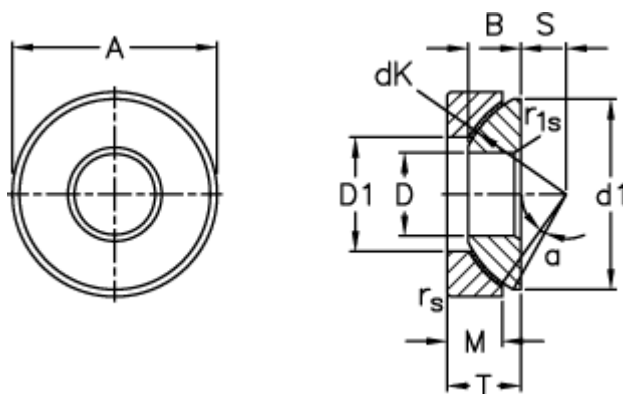

A	= 340 0 -0,045	rs, r1s min	= 1.5
B	= 80	S	= 70
D	= 200 0 -0,030	Static axial load C0 (kN)	= 7100
d1 max	= 320	T	= 87 +0,25 -0,80
D1 min	= 247	Tilt angle	= 1
dK	= 365	Weight	= 34200
Dynamic axial load C (kN)	= 4700		
M	= 66		